



Zylinder

Falls der von Ihnen gewünschte Artikel nicht aufgeführt ist,
stehen wir Ihnen gerne mit Rat und Tat zur Verfügung

Hydraulikzylinder einfachwirkend ohne Befestigung

Bestell-Nr.	Ø Stange mm	Hub mm	Druck max. bar	Einbaumaß mm
Zylinder EPL 20-100 EW	20	100	250	200
Zylinder EPL 30-200 EW	30	200	250	316
Zylinder EPL 30-250 EW	30	250	250	366
Zylinder EPL 30-300 EW	30	300	250	416
Zylinder EPL 30-350 EW	30	350	250	466
Zylinder EPL 30-400 EW	30	400	250	516
Zylinder EPL 30-500 EW	30	500	250	616
Zylinder EPL 40-200 EW	40	200	250	339
Zylinder EPL 40-250 EW	40	250	250	389
Zylinder EPL 40-300 EW	40	300	250	432
Zylinder EPL 40-350 EW	40	350	250	489
Zylinder EPL 40-400 EW	40	400	250	532
Zylinder EPL 40-500 EW	40	500	250	632
Zylinder EPL 50-300 EW	50	300	250	456
Zylinder EPL 50-400 EW	50	400	250	556
Zylinder EPL 50-500 EW	50	500	250	656
Zylinder EPL 50-600 EW	50	600	250	756
Zylinder EPL 60-300 EW	60	300	250	470
Zylinder EPL 60-400 EW	60	400	250	570
Zylinder EPL 60-500 EW	60	500	250	670
Zylinder EPL 60-600 EW	60	600	250	770

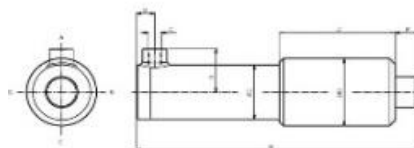



Hydraulikzylinder einfachwirkend mit Befestigung (Bohrung)

Bestell-Nr.	Ø Stange mm	Ø Bolzen mm	Hub mm	Druck max. bar	Einbaumaß mm
Zylinder EW 20-100ST	20	10,2 / 10,2	100	250	178
Zylinder EW 20-150ST	20	10,2 / 10,2	150	250	228
Zylinder EW 20-200ST	20	10,2 / 10,2	200	250	278
Zylinder EW 20-250ST	20	10,2 / 10,2	250	250	328
Zylinder EW 25-100CB	25	14,2 / 14,2	100	250	190
Zylinder EW 25-200CB	25	14,2 / 14,2	200	250	290
Zylinder EW 25-300CB	25	14,2 / 14,2	300	250	390
Zylinder EW 30-100ST	30	15,2 / 15,2	100	250	204
Zylinder EW 30-200CB	30	16,2 / 16,2	200	250	300
Zylinder EW 30-300CB	30	16,2 / 16,2	300	250	400
Zylinder EW 30-350ST	30	15,2 / 15,2	350	250	454
Zylinder EW 30-400CB	30	16,2 / 16,2	400	250	500
Zylinder EW 30-500ST	30	15,2 / 15,2	500	250	604
Zylinder EW 30-550CB	30	16,2 / 16,2	550	250	650
Zylinder EW 30-600ST	30	15,2 / 15,2	600	250	704
Zylinder EW 30-700CB	30	16,2 / 16,2	700	250	800
Zylinder EW 40-200CB	40	23 / 23	200	250	330
Zylinder EW 40-250CB	40	23 / 23	250	250	480
Zylinder EW 40-300CB	40	23 / 23	300	250	432
Zylinder EW 40-350ST	40	20,4 / 20,4	350	250	482
Zylinder EW 40-400CB	40	23 / 23	400	250	532
Zylinder EW 40-550CB	40	23 / 23	550	250	680
Zylinder EW 40-600ST	40	20,4 / 20,4	600	250	732
Zylinder EW 40-700CB	40	23 / 23	700	250	830
Zylinder EW 45-200CB	45	23 / 23	200	250	330
Zylinder EW 45-300CB	45	23 / 23	300	250	430
Zylinder EW 45-400CB	45	23 / 23	400	250	530
Zylinder EW 45-550CB	45	23 / 23	550	250	680
Zylinder EW 45-700CB	45	23 / 23	700	250	830
Zylinder EW 50-200CB	50	25,25 / 25,25	200	250	361
Zylinder EW 50-300CB	50	25,25 / 25,25	300	250	461
Zylinder EW 50-400CB	50	25,25 / 25,25	400	250	561
Zylinder EW 50-500ST	50	25,4 / 25,4	500	250	661
Zylinder EW 50-550CB	50	25,25 / 25,25	550	250	710
Zylinder EW 50-600ST	50	25,4 / 25,4	600	250	761
Zylinder EW 50-700 CB	50	25,25 / 25,25	700	250	860

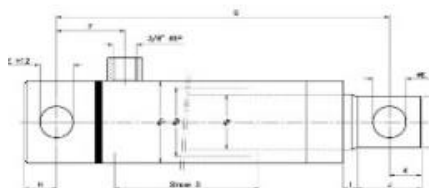



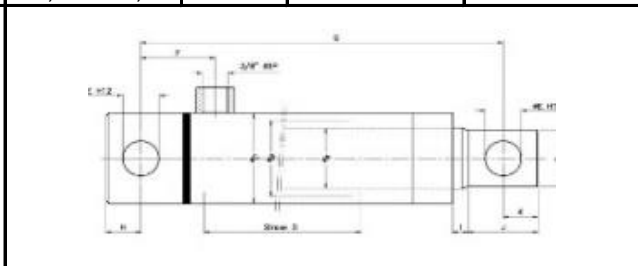

Hydraulikzylinder einfachwirkend mit Befestigung (Bohrung)

Bestell-Nr.	Ø Stange mm	Ø Bolzen mm	Hub mm	Druck max. bar	Einbaumaß mm
Zylinder EW 55-300CB	55	25,25 / 25,25	300	250	460
Zylinder EW 55-550CB	55	25,25 / 25,25	550	250	710
Zylinder EW 55-700CB	55	25,25 / 25,25	700	250	860
Zylinder EW 60-200CB	60	25,25 / 25,25	200	250	360
Zylinder EW 60-300CB	60	25,25 / 25,25	300	250	460
Zylinder EW 60-400CB	60	25,25 / 25,25	400	250	570
Zylinder EW 60-550CB	60	25,25 / 25,25	550	250	710
Zylinder EW 60-700CB	60	25,25 / 25,25	700	250	860
Zylinder EW 70-300CB	70	30,25 / 30,25	300	250	509
Zylinder EW 70-400CB	70	30,25 / 30,25	400	250	609
Zylinder EW 70-500CB	70	30,25 / 30,25	500	250	709



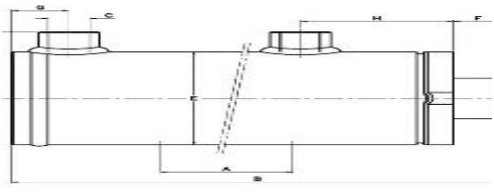

Hydraulikzylinder doppelwirkend ohne Befestigung						
Bestell-Nr.	Ø Stange mm	Ø Kolben mm	Hub mm	Ø Bolzen	Druck max. bar	Einbaumaß mm
Zylinder DW 16-25-100	16	25	100	1/4"	250	230
Zylinder DW 16-25-125	16	25	125	1/4"	250	255
Zylinder DW 16-25-150	16	25	150	1/4"	250	280
Zylinder DW 16-25-175	16	25	175	1/4"	250	305
Zylinder DW 16-25-200	16	25	200	1/4"	250	330
Zylinder DW 16-25-250	16	25	250	1/4"	250	380
Zylinder DW 20-30-100	20	30	100	1/4"	250	236
Zylinder DW 20-30-125	20	30	125	1/4"	250	261
Zylinder DW 20-30-150	20	30	150	1/4"	250	286
Zylinder DW 20-30-175	20	30	175	1/4"	250	311
Zylinder DW 20-30-200	20	30	200	1/4"	250	336
Zylinder DW 20-30-250	20	30	250	1/4"	250	386
Zylinder DW 20-30-300	20	30	300	1/4"	250	436
Zylinder DW 20-30-350	20	30	350	1/4"	250	486
Zylinder DW 25-40-100	25	40	100	3/8"	250	246
Zylinder DW 25-40-125	25	40	125	3/8"	250	271
Zylinder DW 25-40-150	25	40	150	3/8"	250	296
Zylinder DW 25-40-175	25	40	175	3/8"	250	321
Zylinder DW 25-40-200	25	40	200	3/8"	250	346
Zylinder DW 25-40-250	25	40	250	3/8"	250	396
Zylinder DW 25-40-300	25	40	300	3/8"	250	446
Zylinder DW 25-40-350	25	40	350	3/8"	250	496
Zylinder DW 25-40-400	25	40	400	3/8"	250	546
Zylinder DW 25-40-450	25	40	450	3/8"	250	596
Zylinder DW 25-40-500	25	40	500	3/8"	250	646
Zylinder DW 25-40-600	25	40	600	3/8"	250	746
Zylinder DW 25-50x100	25	50	100	3/8"	250	256
Zylinder DW 25-50x125	25	50	125	3/8"	250	281
Zylinder DW 25-50-150	25	50	150	3/8"	250	306
Zylinder DW 25-50-175	25	50	175	3/8"	250	331
Zylinder DW 25-50-200	25	50	200	3/8"	250	356
Zylinder DW 25-50-250	25	50	250	3/8"	250	406
Zylinder DW 25-50-300	25	50	300	3/8"	250	456
Zylinder DW 25-50-350	25	50	350	3/8"	250	506
Zylinder DW 25-50-400	25	50	400	3/8"	250	556
Zylinder DW 25-50-450	25	50	450	3/8"	250	606
Zylinder DW 25-50-500	25	50	500	3/8"	250	656
Zylinder DW 25-50-600	25	50	600	3/8"	250	756
Zylinder DW 25-50-700	25	50	700	3/8"	250	856
Zylinder DW 25-50-800	25	50	800	3/8"	250	956
Zylinder DW 25-50-1000	25	50	1000	3/8"	250	1156







Hydraulikzylinder doppelwirkend ohne Befestigung

Bestell-Nr.	Ø Stange mm	Ø Kolben mm	Hub mm	Ø Bolzen	Druck max. bar	Einbaumaß mm
Zylinder DW 30-60-125	30	60	125	3/8"	250	285
Zylinder DW 30-60-150	30	60	150	3/8"	250	310
Zylinder DW 30-60-175	30	60	175	3/8"	250	335
Zylinder DW 30-60-200	30	60	200	3/8"	250	360
Zylinder DW 30-60-250	30	60	250	3/8"	250	410
Zylinder DW 30-60-300	30	60	300	3/8"	250	460
Zylinder DW 30-60-350	30	60	350	3/8"	250	510
Zylinder DW 30-60-400	30	60	400	3/8"	250	560
Zylinder DW 30-60-450	30	60	450	3/8"	250	610
Zylinder DW 30-60-500	30	60	500	3/8"	250	660
Zylinder DW 30-60-600	30	60	600	3/8"	250	760
Zylinder DW 30-60-800	30	60	800	3/8"	250	960
Zylinder DW 30-60-1000	30	60	1000	3/8"	250	1160
Zylinder DW 35-70-100	35	70	100	3/8"	250	276
Zylinder DW 35-70-125	35	70	125	3/8"	250	301
Zylinder DW 35-70-150	35	70	150	3/8"	250	326
Zylinder DW 35-70-175	35	70	175	3/8"	250	351
Zylinder DW 35-70-200	35	70	200	3/8"	250	376
Zylinder DW 35-70-250	35	70	250	3/8"	250	426
Zylinder DW 35-70-300	35	70	300	3/8"	250	476
Zylinder DW 35-70-350	35	70	350	3/8"	250	526
Zylinder DW 35-70-400	35	70	400	3/8"	250	576
Zylinder DW 35-70-450	35	70	450	3/8"	250	626
Zylinder DW 35-70-500	35	70	500	3/8"	250	676
Zylinder DW 35-70-600	35	70	600	3/8"	250	776
Zylinder DW 35-70-800	35	70	800	3/8"	250	979
Zylinder DW 35-70-1000	35	70	1000	3/8"	250	1176
Zylinder DW 45-80-100	45	80	100	1/2"	250	291
Zylinder DW 45-80-125	45	80	125	1/2"	250	316
Zylinder DW 45-80-150	45	80	150	1/2"	250	341
Zylinder DW 45-80-175	45	80	175	1/2"	250	366
Zylinder DW 45-80-200	45	80	200	1/2"	250	391
Zylinder DW 45-80-250	45	80	250	1/2"	250	441
Zylinder DW 45-80-300	45	80	300	1/2"	250	491
Zylinder DW 45-80-350	45	80	350	1/2"	250	541
Zylinder DW 45-80-400	45	80	400	1/2"	250	591
Zylinder DW 45-80-450	45	80	450	1/2"	250	641
Zylinder DW 45-80-500	45	80	500	1/2"	250	691
Zylinder DW 45-80-600	45	80	600	1/2"	250	791
Zylinder DW 45-80-800	45	80	800	1/2"	250	991
Zylinder DW 45-80-900	45	80	900	1/2"	250	1091
Zylinder DW 45-80-1000	45	80	1000	1/2"	250	1191

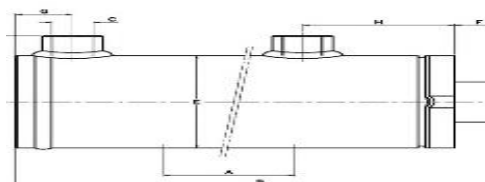



Hydraulikzylinder doppelwirkend mit Befestigung (Bohrung)

Bestell-Nr.	Ø Stange mm	Ø Kolben mm	Hub mm	Ø Bolzen mm	Druck max. bar	Einbaumaß mm
Zylinder DW 16-32-50ST	16	32	50	15,2 / 15,2	250	184
Zylinder DW 16-32-100ST	16	32	100	15,2 / 15,2	250	234
Zylinder DW 16-32-150ST	16	32	150	15,2 / 15,2	250	284
Zylinder DW 16-32-200ST	16	32	200	15,2 / 15,2	250	334
Zylinder DW 20-32-300CB	20	32	300	16,2 / 16,2	250	455
Zylinder DW 20-32-400CB	20	32	400	16,2 / 16,2	250	555
Zylinder DW 20-32-500CB	20	32	500	16,2 / 16,2	250	655
Zylinder DW 20-32-600CB	20	32	600	16,2 / 16,2	250	755
Zylinder DW 20-32-700CB	20	32	700	16,2 / 16,2	250	855
Zylinder DW 25-40-100ST	25	40	100	20,4 / 20,4	250	246
Zylinder DW 25-40-200ST	25	40	200	20,4 / 20,4	250	346
Zylinder DW 25-40-250ST	25	40	250	20,4 / 20,4	250	396
Zylinder DW 25-40-300ST	25	40	300	20,4 / 20,4	250	446
Zylinder DW 25-40-400ST	25	40	400	20,4 / 20,4	250	546
Zylinder DW 25-40-500ST	25	40	500	20,4 / 20,4	250	646
Zylinder DW 25-40-600CB	25	40	600	20,3 / 20,3	250	670
Zylinder DW 25-40-700CB	25	40	700	20,3 / 20,3	250	870
Zylinder DW 25-40-800CB	25	40	800	20,3 / 20,3	250	970
Zylinder DW 25-40-900CB	25	40	900	20,3 / 20,3	250	1070
Zylinder DW 30-50-100CB	30	50	100	25,3 / 25,3	250	300
Zylinder DW 30-50-200ST	30	50	200	25,4 / 25,4	250	373
Zylinder DW 30-50-250ST	30	50	250	25,4 / 25,4	250	423
Zylinder DW 30-50-300ST	30	50	300	25,4 / 25,4	250	473
Zylinder DW 30-50-350ST	30	50	350	25,4 / 25,4	250	523
Zylinder DW 30-50-400ST	30	50	400	25,4 / 25,4	250	573
Zylinder DW 30-50-500ST	30	50	500	25,4 / 25,4	250	673
Zylinder DW 30-50-600ST	30	50	600	25,4 / 25,4	250	773
Zylinder DW 30-50-700ST	30	50	700	25,4 / 25,4	250	873
Zylinder DW 30-50-800CB	30	50	800	25,3 / 25,3	250	1000
Zylinder DW 30-50-900ST	30	50	900	25,4 / 25,4	250	1073
Zylinder DW 30-50-1000CB	30	50	1000	25,3 / 25,3	250	1200
Zylinder DW 30-60-100CB	30	60	100	25,3 / 25,3	250	300
Zylinder DW 30-60-200ST	30	60	200	25,4 / 25,4	250	373
Zylinder DW 30-60-250ST	30	60	250	25,4 / 25,4	250	423
Zylinder DW 30-60-300ST	30	60	300	25,4 / 25,4	250	473
Zylinder DW 30-60-400ST	30	60	400	25,4 / 25,4	250	573
Zylinder DW 30-60-500ST	30	60	500	25,4 / 25,4	250	673
Zylinder DW 30-60-600ST	30	60	600	25,4 / 25,4	250	773
Zylinder DW 30-60-700ST	30	60	700	25,4 / 25,4	250	873
Zylinder DW 30-60-1000ST	30	60	1000	25,4 / 25,4	250	1173

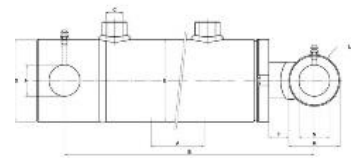



Hydraulikzylinder doppelwirkend mit Befestigung (Bohrung)

Bestell-Nr.	Ø Stange mm	Ø Kolben mm	Hub mm	Ø Bolzen mm	Druck max. bar	Einbaumaß mm
Zylinder DW 35-60-200ST	35	60	200	25,4 / 25,4	250	373
Zylinder DW 35-60-250ST	35	60	250	25,4 / 25,4	250	423
Zylinder DW 35-60-300ST	35	60	300	25,4 / 25,4	250	473
Zylinder DW 35-60-400ST	35	60	400	25,4 / 25,4	250	573
Zylinder DW 35-60-500ST	35	60	500	25,4 / 25,4	250	673
Zylinder DW 35-60-600ST	35	60	600	25,4 / 25,4	250	773
Zylinder DW 35-60-700ST	35	60	700	25,4 / 25,4	250	873
Zylinder DW 35-60-1000ST	35	60	1000	25,4 / 25,4	250	1173
Zylinder DW 35-70-200ST	35	70	200	30,4 / 30,4	250	396
Zylinder DW 35-70-250ST	35	70	250	30,4 / 30,4	250	446
Zylinder DW 35-70-300ST	35	70	300	30,4 / 30,4	250	496
Zylinder DW 35-70-400ST	35	70	400	30,4 / 30,4	250	596
Zylinder DW 35-70-500ST	35	70	500	30,4 / 30,4	250	696
Zylinder DW 35-70-600ST	35	70	600	30,4 / 30,4	250	796
Zylinder DW 40-70-700CB	40	70	700	30,3 / 30,3	250	910
Zylinder DW 40-70-800CB	40	70	800	30,3 / 30,3	250	1010
Zylinder DW 40-70-1000CB	40	70	1000	30,3 / 30,3	250	1210
Zylinder DW 40-80-200CB	40	80	200	30,3 / 30,3	250	410
Zylinder DW 40-80-250ST	40	80	250	30,4 / 30,4	250	455
Zylinder DW 40-80-300ST	40	80	300	30,4 / 30,4	250	505
Zylinder DW 40-80-400ST	40	80	400	30,4 / 30,4	250	660
Zylinder DW 40-80-500ST	40	80	500	30,4 / 30,4	250	705
Zylinder DW 40-80-600ST	40	80	600	30,4 / 30,4	250	808
Zylinder DW 40-80-700ST	40	80	700	30,4 / 30,4	250	905
Zylinder DW 40-80-800ST	40	80	800	30,4 / 30,4	250	1005
Zylinder DW 40-80-900ST	40	80	900	30,4 / 30,4	250	1105
Zylinder DW 40-80-1000ST	40	80	1000	30,4 / 30,4	250	1205
Zylinder DW 50-80-300ST	50	80	300	30,4 / 30,4	250	505
Zylinder DW 50-80-400ST	50	80	400	30,4 / 30,4	250	605
Zylinder DW 50-80-500ST	50	80	500	30,4 / 30,4	250	705
Zylinder DW 50-80-600ST	50	80	600	30,4 / 30,4	250	805
Zylinder DW 50-80-700ST	50	80	700	30,4 / 30,4	250	905
Zylinder DW 50-80-900ST	50	80	900	30,4 / 30,4	250	1105
Zylinder DW 50-100-200ST	50	100	200	30,3 / 30,3	250	436
Zylinder DW 50-100-300CB	50	100	300	30,3 / 30,3	250	525
Zylinder DW 50-100-400CB	50	100	400	30,3 / 30,3	250	625
Zylinder DW 50-100-500CB	50	100	500	30,3 / 30,3	250	725
Zylinder DW 50-100-700CB	50	100	700	30,3 / 30,3	250	925
Zylinder DW 50-100-900CB	50	100	900	30,3 / 30,3	250	1125
Zylinder DW 60-100-200ST	60	100	200	40,4 / 40,4	250	436
Zylinder DW 60-100-400ST	60	100	400	40,4 / 40,4	250	636
Zylinder DW 60-100-600ST	60	100	600	40,4 / 40,4	250	836
Zylinder DW 60-100-800ST	60	100	800	40,4 / 40,4	250	1036
Zylinder DW 60-100-1000ST	60	100	1000	40,4 / 40,4	250	1236

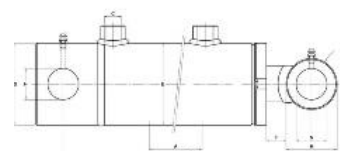



Hydraulikzylinder GK doppelwirkend mit Befestigung (Gelenkkopf)

Bestell-Nr.	Ø Stange mm	Ø Kolben mm	Hub mm	Ø Bolzen mm	Druck max. bar	Einbaumaß mm
Zylinder DW 16-25-100GK	16	25	100	15 / 15	250	267
Zylinder DW 16-25-150GK	16	25	150	15 / 15	250	317
Zylinder DW 16-25-200GK	16	25	200	15 / 15	250	367
Zylinder DW 16-25-250GK	16	25	250	15 / 15	250	417
Zylinder DW 20-32-100GK	20	32	100	15 / 15	250	273
Zylinder DW 20-32-150GK	20	32	150	15 / 15	250	323
Zylinder DW 20-32-200GK	20	32	200	15 / 15	250	373
Zylinder DW 20-32-250GK	20	32	250	15 / 15	250	423
Zylinder DW 20-32-300GK	20	32	300	15 / 15	250	473
Zylinder DW 20-32-350GK	20	32	350	15 / 15	250	523
Zylinder DW 20-32-400GK	20	32	400	15 / 15	250	573
Zylinder DW 20-32-500GK	20	32	500	15 / 15	250	673
Zylinder DW 25-40-100GK	25	40	100	20 / 20	250	292
Zylinder DW 25-40-150GK	25	40	150	20 / 20	250	342
Zylinder DW 25-40-200GK	25	40	200	20 / 20	250	392
Zylinder DW 25-40-250GK	25	40	250	20 / 20	250	442
Zylinder DW 25-40-300GK	25	40	300	20 / 20	250	492
Zylinder DW 25-40-350GK	25	40	350	20 / 20	250	542
Zylinder DW 25-40-400GK	25	40	400	20 / 20	250	592
Zylinder DW 25-40-500GK	25	40	500	20 / 20	250	692
Zylinder DW 25-40-600GK	25	40	600	20 / 20	250	792
Zylinder DW 25-40-700GK	25	40	700	20 / 20	250	892
Zylinder DW 30-50-100GK	30	50	100	25 / 25	250	314
Zylinder DW 30-50-150GK	30	50	150	25 / 25	250	364
Zylinder DW 30-50-200GK	30	50	200	25 / 25	250	414
Zylinder DW 30-50-250GK	30	50	250	25 / 25	250	464
Zylinder DW 30-50-300GK	30	50	300	25 / 25	250	514
Zylinder DW 30-50-350GK	30	50	350	25 / 25	250	564
Zylinder DW 30-50-400GK	30	50	400	25 / 25	250	614
Zylinder DW 30-50-500GK	30	50	500	25 / 25	250	714
Zylinder DW 30-50-600GK	30	50	600	25 / 25	250	814
Zylinder DW 30-50-700GK	30	50	700	25 / 25	250	914
Zylinder DW 30-50-800GK	30	50	800	25 / 25	250	1014

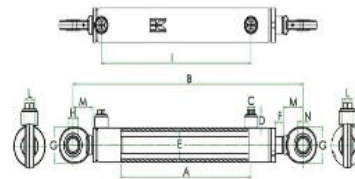



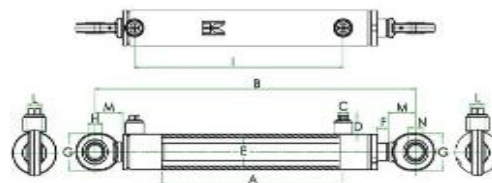

Hydraulikzylinder GK doppelwirkend mit Befestigung (Gelenkkopf)

Bestell-Nr.	Ø Stange mm	Ø Kolben mm	Hub mm	Ø Bolzen mm	Druck max. bar	Einbaumaß mm
Zylinder DW 30-60-100GK	30	60	100	30 / 30	250	338
Zylinder DW 30-60-150GK	30	60	150	30 / 30	250	388
Zylinder DW 30-60-200GK	30	60	200	30 / 30	250	438
Zylinder DW 30-60-250GK	30	60	250	30 / 30	250	488
Zylinder DW 30-60-300GK	30	60	300	30 / 30	250	538
Zylinder DW 30-60-350GK	30	60	350	30 / 30	250	588
Zylinder DW 30-60-400GK	30	60	400	30 / 30	250	638
Zylinder DW 30-60-500GK	30	60	500	30 / 30	250	738
Zylinder DW 30-60-600GK	30	60	600	30 / 30	250	838
Zylinder DW 30-60-700GK	30	60	700	30 / 30	250	938
Zylinder DW 30-60-800GK	30	60	800	30 / 30	250	1038
Zylinder DW 35-70-100GK	35	70	100	35 / 35	250	360
Zylinder DW 35-70-150GK	35	70	150	35 / 35	250	410
Zylinder DW 35-70-200GK	35	70	200	35 / 35	250	460
Zylinder DW 35-70-250GK	35	70	250	35 / 35	250	510
Zylinder DW 35-70-300GK	35	70	300	35 / 35	250	560
Zylinder DW 35-70-350GK	35	70	350	35 / 35	250	610
Zylinder DW 35-70-400GK	35	70	400	35 / 35	250	660
Zylinder DW 35-70-500GK	35	70	500	35 / 35	250	760
Zylinder DW 35-70-600GK	35	70	600	35 / 35	250	860
Zylinder DW 35-70-700GK	35	70	700	35 / 35	250	960
Zylinder DW 35-70-800GK	35	70	800	35 / 35	250	1060
Zylinder DW 45-80-100GK	45	80	100	40 / 40	250	394
Zylinder DW 45-80-150GK	45	80	150	40 / 40	250	444
Zylinder DW 45-80-200GK	45	80	200	40 / 40	250	494
Zylinder DW 45-80-250GK	45	80	250	40 / 40	250	544
Zylinder DW 45-80-300GK	45	80	300	40 / 40	250	594
Zylinder DW 45-80-350GK	45	80	350	40 / 40	250	644
Zylinder DW 45-80-400GK	45	80	400	40 / 40	250	694
Zylinder DW 45-80-500GK	45	80	500	40 / 40	250	794
Zylinder DW 45-80-600GK	45	80	600	40 / 40	250	894
Zylinder DW 45-80-700GK	45	80	700	40 / 40	250	994
Zylinder DW 45-80-800GK	45	80	800	40 / 40	250	1094





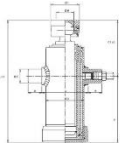

Teleskopzylinder mit Kugel und Pfanne 2stufig						
Bestell-Nr.	Stufen mm 2stufig	Druck bar	Hub mm	seitlicher Bolzen Ø	Abstand zwischen den Bolzen	Einbaumaß mm
Zylinder TC2020	46/61	180	455	35	100	340
Zylinder TC3021	61/76	180	495	35	115	412
Zylinder TC3022	61/76	180	595	35	115	460
Zylinder TC3023	61/76	180	695	35	115	510
Zylinder TC3024	61/76	180	795	35	115	560
Zylinder TC3026	61/76	180	995	35	115	665
Zylinder TC4021	68/88	180	595	35	130	465
Zylinder TC4024	68/88	180	795	35	130	520
Zylinder TC4023	88/107	180	695	40	150	565
Zylinder TC4027	88/107	180	1095	40	150	720

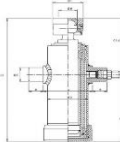

Teleskopzylinder mit Kugel und Pfanne 3stufig						
Bestell-Nr.	Stufen mm 3stufig	Druck bar	Hub mm	seitlicher Ø Bolzen	Abstand zwischen den Bolzen	Einbaumaß mm
Zylinder TC2031	46/61/76	180	500	35	115	322
Zylinder TC2032	46/61/76	180	593	35	115	352
Zylinder TC2033	46/61/76	180	683	35	115	382
Zylinder TC2034	46/61/76	180	790	35	115	417
Zylinder TC2035	46/61/76	180	893	35	115	452
Zylinder TC2036	46/61/76	180	1043	35	115	502
Zylinder TC2038	46/61/76	180	1490	35	115	652
Zylinder TC3031	61/76/91	180	593	35	135	367
Zylinder TC3032	61/76/91	180	683	35	135	397
Zylinder TC3033	61/76/91	180	785	35	135	432
Zylinder TC3034	61/76/91	180	893	35	135	467
Zylinder TC3035	61/76/91	180	1043	35	135	517
Zylinder TC3036	61/76/91	180	1283	35	135	597
Zylinder TC3037	61/76/91	180	1493	35	135	667
Zylinder TC4031	68/88/107	180	743	40	150	417
Zylinder TC4032	68/88/107	180	785	40	150	432
Zylinder TC4033	68/88/107	180	893	40	150	467
Zylinder TC4034	68/88/107	180	1043	40	150	517
Zylinder TC4035	68/88/107	180	1283	40	150	597
Zylinder TC4036	88/107/126	180	1273	45	175	610
Zylinder TC4038	88/107/126	180	1483	45	175	680







Teleskopzylinder mit Kugel und Pfanne 4stufig						
Bestell-Nr.	Stufen mm 4stufig	Druck bar	Hub mm	seitlicher Ø Bolzen	Abstand zwischen den Bolzen	Einbaumaß mm
Zylinder TC3041	61/76/91/107	180	670	40	150	382
Zylinder TC3042	61/76/91/107	180	830	40	150	382
Zylinder TC3043	61/76/91/107	180	950	40	150	412
Zylinder TC3044	61/76/91/107	180	1050	40	150	437
Zylinder TC3045	61/76/91/107	180	1190	40	150	472
Zylinder TC3046	61/76/91/107	180	1290	40	150	497
Zylinder TC3047	61/76/91/107	180	1510	40	150	552
Zylinder TC3048	61/76/91/107	180	1710	40	150	602
Zylinder TC3049	61/76/91/107	180	1990	40	150	672
Zylinder TC3063	46/61/76/91	180	790	35	135	360
Zylinder TC3065	46/61/76/91	180	1050	35	135	425
Zylinder TC4041	68/88/107/126	180	1040	45	175	440
Zylinder TC4042	68/88/107/126	180	1220	45	175	487
Zylinder TC4043	68/88/107/126	180	1500	45	175	557
Zylinder TC4044	68/88/107/126	180	1700	45	175	607
Zylinder TC4045	88/107/126/145	180	1490	50	210	564
Zylinder TC4046	88/107/126/145	180	1690	50	210	614
Zylinder TC4047	88/107/126/145	180	1970	50	210	684
Zylinder TC4048	107/126/145/165	180	1920	50	230	698

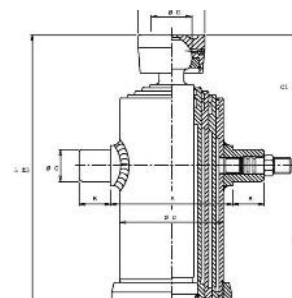



Teleskopzylinder mit Kugel und Pfanne 5stufig

Bestell-Nr.	Stufen mm 5stufig	Druck bar	Hub mm	seitlicher Ø Bolzen	Abstand zwischen den Bolzen	Einbaumaß mm
Zylinder TC3050	46/61/76/91/107	180	690	40	150	305
Zylinder TC3051	61/76/91/107/126	180	980	45	175	380
Zylinder TC3052	61/76/91/107/126	180	1230	45	175	430
Zylinder TC3053	61/76/91/107/126	180	1480	45	175	480
Zylinder TC3054	61/76/91/107/126	180	1880	45	175	560
Zylinder TC3055	61/76/91/107/126	180	2130	45	175	610
Zylinder TC3056	61/76/91/107/126	180	2480	45	175	680
Zylinder TC3092	46/61/76/91/107	180	1040	40	150	373
Zylinder TC3093	46/61/76/91/107	180	1190	40	150	405
Zylinder TC4050	68/88/107/126/145	180	1870	50	210	565
Zylinder TC4051	68/88/107/126/145	180	2120	50	210	615
Zylinder TC4052	88/107/126/145/165	180	2100	50	230	615
Zylinder TC4053	88/107/126/145/165	180	2450	50	230	695
Zylinder TC5002	68/88/107/126/145	180	2470	50	210	685
Zylinder TC5010	88/107/126/145/165	180	3490	50	230	915
Zylinder TC5034	107/126/145/165/187	180	2005	50	252	633

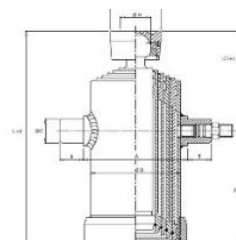

Teleskopzylinder mit Kugel und Pfanne 6stufig

Bestell-Nr.	Stufen mm 6stufig	Druck bar	Hub mm	seitlicher Ø Bolzen	Abstand zwischen den Bolzen	Einbaumaß mm
Zylinder TC4060	68/88/107/126/145/165	180	2225	50	230	573
Zylinder TC4061	68/88/107/126/145/165	180	2490	50	230	623
Zylinder TC4062	68/88/107/126/145/165	180	2910	50	230	693
Zylinder TC4063	68/88/107/126/145/165	180	3405	50	230	789
Zylinder TC4059	68/88/107/126/145/165	180	1810	50	230	503
Zylinder TC6012	46/61/76/91/107/126	180	2977	45	175	668
Zylinder TC6020	61/76/91/107/126/145	180	1465	50	210	430
Zylinder TC6024	61/76/91/107/126/145	180	2955	50	210	680
Zylinder TC6056	88/107/126/145/165/187	180	3265	50	252	785

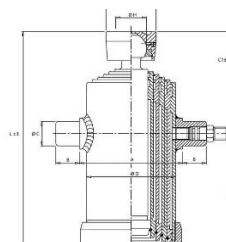

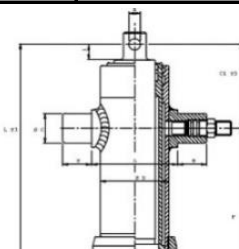

Teleskopzylinder mit Auge 2stufig						
Bestell-Nr.	Stufen mm 2stufig	Druck bar	Hub mm	seitlicher Ø Bolzen	Abstand zwischen den Bolzen	Einbaumaß mm
Zylinder TC2020F	46/61	180	455	35	100	380
Zylinder TC2021F	46/61	180	525	35	100	375
Zylinder TC3022F	61/76	180	595	35	115	415
Zylinder TC3023F	61/76	180	695	35	115	465
Zylinder TC3024F	61/76	180	795	35	115	515
Zylinder TC4026F	88/107	180	895	40	150	580
Zylinder TG4027F	88/107	180	1095	40	150	680

Teleskopzylinder mit Auge 3stufig						
Bestell-Nr.	Stufen mm 3stufig	Druck bar	Hub mm	seitlicher Ø Bolzen	Abstand zwischen den Bolzen	Einbaumaß mm
Zylinder TC2031F	46/61/76	180	500	35	115	282
Zylinder TC2032F	46/61/76	180	593	35	115	312
Zylinder TC2034F	46/61/76	180	790	35	115	377
Zylinder TC2036F	46/61/76	180	1043	35	115	462
Zylinder TC3030F	61/76/91	180	500	35	135	292
Zylinder TC3034F	61/76/91	180	893	35	135	422
Zylinder TC3035F	61/76/91	180	1043	35	135	472
Zylinder TC4033F	68/88/107	180	893	40	150	438
Zylinder TC4034F	68/88/107	180	1043	40	150	482
Zylinder TC4035F	68/88/107	180	1283	40	150	562
Zylinder TC4036F	88/107/126	180	1273	45	175	570
Zylinder TC4038F	88/107/126	180	1483	45	175	637



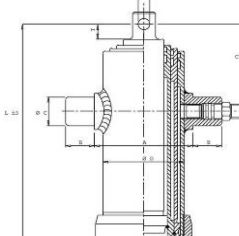



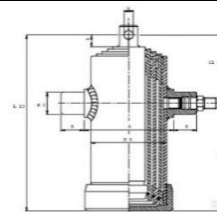

Teleskopzylinder mit Auge 4stufig

Bestell-Nr.	Stufen mm 4stufig	Druck bar	Hub mm	seitlicher Ø Bolzen	Abstand zwischen den Bolzen	Einbaumaß mm
Zylinder TC3042F	61/76/91/107	180	830	40	150	337
Zylinder TC3043F	61/76/91/107	180	950	40	150	367
Zylinder TC3044F	61/76/91/107	180	1050	40	150	392
Zylinder TC3045F	61/76/91/107	180	1190	40	150	427
Zylinder TC3046F	61/76/91/107	180	1290	40	150	452
Zylinder TC3047F	61/76/91/107	180	1510	40	150	507
Zylinder TC3048F	61/76/91/107	180	1710	40	150	557
Zylinder TC3049F	61/76/91/107	180	1990	40	150	627
Zylinder TC4042F	68/88/107/126	180	1220	45	175	455
Zylinder TC4043F	68/88/107/126	180	1500	45	175	525
Zylinder TC4044F	68/88/107/126	180	1700	45	175	575
Zylinder TC4045F	88/107/126/145	180	1490	50	210	520
Zylinder TC4046F	88/107/126/145	180	1690	50	210	570
Zylinder TC4047F	88/107/126/145	180	1970	50	210	640
Zylinder TC4048F	107/126/145/165	180	1920	50	230	657
Zylinder TC4072F	88/107/126/145	180	1210	50	210	490
Zylinder TC4083F	107/126/145/165	180	1670	50	230	628



Teleskopzylinder mit Auge 5stufig

Bestell-Nr.	Stufen mm 5stufig	Druck bar	Hub mm	seitlicher Ø Bolzen	Abstand zwischen den Bolzen	Einbaumaß mm
Zylinder TC3053F	61/76/91/107/126	180	1480	45	175	435
Zylinder TC3054F	61/76/91/107/126	180	1880	45	175	515
Zylinder TC3055F	61/76/91/107/126	180	2130	45	175	565
Zylinder TC3056F	61/76/91/107/126	180	2480	45	175	635
Zylinder TC3096F	46/61/76/91/107	180	2490	40	150	625
Zylinder TC4051F	68/88/107/126/145	180	2120	50	210	575
Zylinder TC4052F	88/107/126/145/165	180	2100	50	230	575
Zylinder TC4053F	88/107/126/145/165	180	2450	50	230	655
Zylinder TC5002F	68/88/107/126/145	180	2470	50	210	645
Zylinder TC5011F	88/107/126/145/165	180	2990	50	230	775

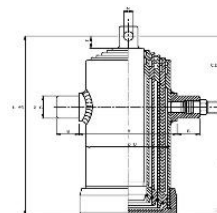



Teleskopzylinder mit Auge 6stufig

Bestell-Nr.	Stufen mm 6stufig	Druck bar	Hub mm	seitlicher Ø Bolzen	Abstand zwischen den Bolzen	Einbaumaß mm
Zylinder TC4060F	68/88/107/126/145/165	180	2225	50	230	533
Zylinder TC4061F	68/88/107/126/145/165	180	2490	50	230	587
Zylinder TC4062F	68/88/107/126/145/165	180	2910	50	230	653
Zylinder TC4065F	68/88/107/126/145/165	180	3765	50	230	815
Zylinder TC6025F	61/76/91/107/126/145	180	3585	50	210	768

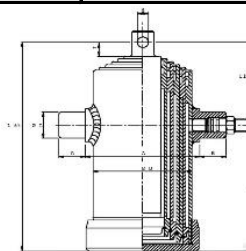

Bremszylinder Typ EPL ohne Federrückstellung einfachwirkend

Bestell-Nr.	Stange Ø	Anschluss	Hub mm	Nenndruck bar	Länge
Zylinder EPL30110	30		110	200	232

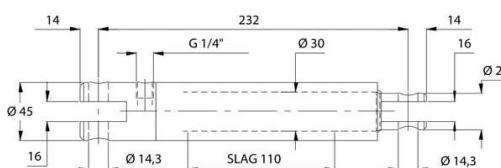

Bremszylinder Typ BC ohne Federrückstellung einfachwirkend

Bestell-Nr.	Stange Ø	Anschluss	Hub mm	Nenndruck bar	Länge
Zylinder BC20100	20	3/8" BSP	100	200	235
Zylinder BC25100	25	3/8" BSP	100	200	235
Zylinder BC30100	30	3/8" BSP	100	200	250
Zylinder BC2580	25	3/8" BSP	80	200	270

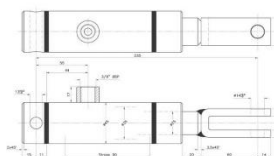
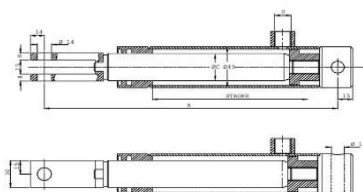



Bremszylinder Typ BCS mit Federrückstellung einfachwirkend

Bestell-Nr.	Stange Ø	Anschluss	Hub mm	Nenndruck bar	Länge
Zylinder BCS20100	20	3/8" BSP	100	200	300
Zylinder BCS25100	25	3/8" BSP	100	200	300
Zylinder BCS30100	30	3/8" BSP	100	200	300
Zylinder BCS2595	25	3/8" BSP	95	200	240
Zylinder BCS2580	25	3/8" BSP	80	250	240

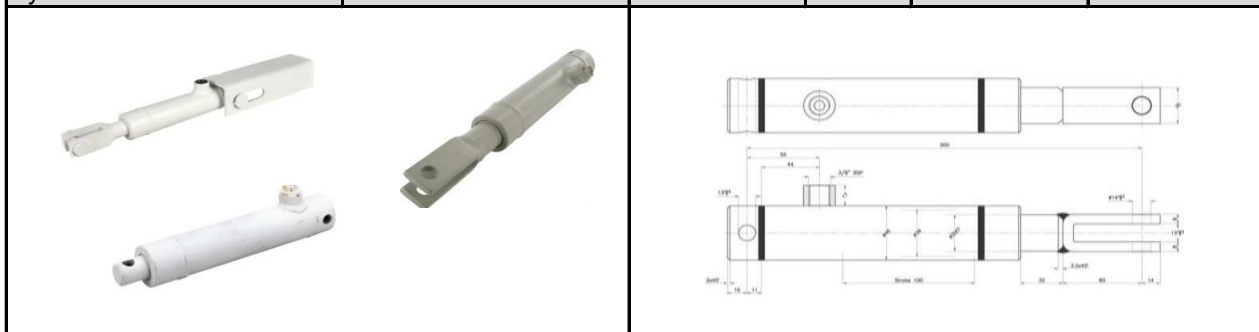

Bremszylinder Typ BC mit Federrückstellung einfachwirkend mit Bodengewinde M 16x1,5

Bestell-Nr.	Stange Ø	Anschluss	Hub mm	Nenndruck bar	Länge
Zylinder BC2080TH	20	3/8" BSP	80	180	210
Zylinder BC2580TH	25	3/8" BSP	80	180	230
Zylinder BC3080TH	30	3/8" BSP	80	180	230

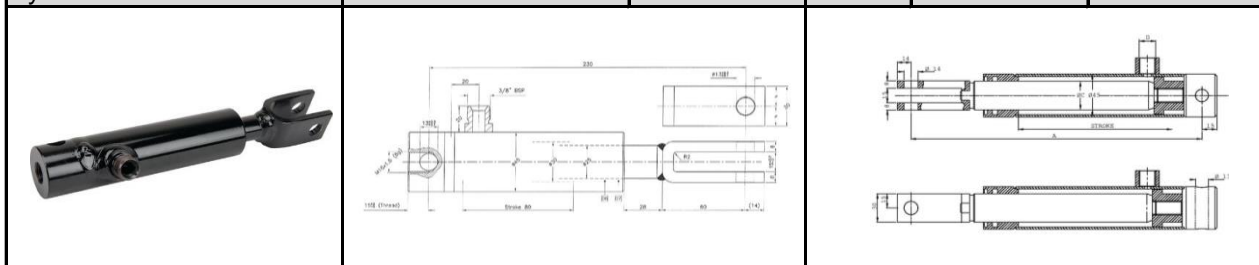

Bremszylinder Typ BCB einfachwirkend

Bestell-Nr.	Stange Ø	Anschluss	Hub mm	Nenndruck bar	Länge
Zylinder BC2098	20	3/8" BSP	98	180	239
Zylinder BC2598	25	3/8" BSP	98	180	239
Zylinder BC3098	30	3/8" BSP	98	180	239





Hydraulischer Oberlenker-Zylinder doppelwirkend

Bestell-Nr.	Ø Stange mm	Ø A mm	Hub mm	Ø Bolzen mm	Druck max bar	Einbaumaß mm
Oberlenker-Zylinder DW	30	60	100	19,4 / 19,4	250	340
Oberlenker-Zylinder DW	30	60	150	19,4 / 19,4	250	390
Oberlenker-Zylinder DW	30	60	200	19,4 / 19,4	250	440
Oberlenker-Zylinder DW	30	60	200	25,7 / 25,7	250	440
Oberlenker-Zylinder DW	30	60	285	19,4 / 19,4	250	550
Oberlenker-Zylinder DW	30	60	285	25,7 / 25,7	250	550
Oberlenker-Zylinder DW	30	60	350	25,7 / 25,7	250	610
Oberlenker-Zylinder DW	35	70	250	25,7 / 25,7	250	550
Oberlenker-Zylinder DW	35	70	300	25,7 / 25,7	250	580
Oberlenker-Zylinder DW	35	70	250	25,7 / 25,7	250	550

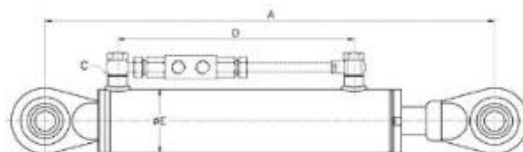

Hydraulischer Oberlenker-Zylinder mit Fanghaken doppelwirkend

Bestell-Nr.	Ø Stange mm	Ø A mm	Hub mm	Ø Bolzen mm	Druck max. bar	Einbaumaß mm
Zylinder DW/Fanghaken	30	60	150	19,4 / 19,4	250	440
Zylinder DW/Fanghaken	30	60	200	19,4 / 19,4	250	490
Zylinder DW/Fanghaken	30	60	285	25,7 / 25,7	250	590
Zylinder DW/Fanghaken	35	73	230	25,7 / 25,7	250	546
Zylinder DW/Fanghaken	35	73	300	25,7 / 25,7	250	620
Zylinder DW/Fanghaken	35	80	250	25,7 / 25,7	250	610
Zylinder DW/Fanghaken	35	80	250	31,6 / 31,6	250	630
Zylinder DW/Fanghaken	35	80	300	25,7 / 25,7	250	640
Zylinder DW/Fanghaken	35	80	300	31,6 / 31,6	250	660

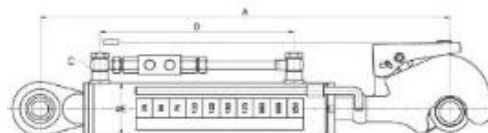



Hydraulischer Oberlenker-Zylinder mit Schlauch doppelwirkend

Bestell-Nr.	Ø Stange mm	Ø A mm	Hub mm	Ø Bolzen mm	Druck max. bar	Einbaumaß mm
Zylinder DW/Schlauch	30	60	150	19,4 / 19,4	250	440
Zylinder DW/Schlauch	35	73	230	25,7 / 25,7	250	546
Zylinder DW/Schlauch	35	73	300	25,7 / 25,7	250	620

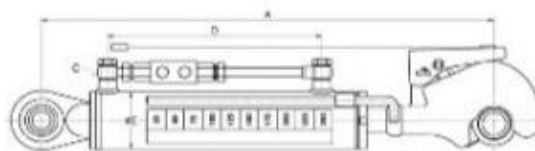

Hydraulischer Oberlenker-Zylinder Kat. 1 mit Schlauch doppelwirkend

Bestell-Nr.	Ø Stange mm	Ø A mm	Hub mm	Ø Bolzen mm	Druck max. bar	Einbaumaß mm
Zylinder Schlauch/Kat.1	30	60	150	19,4 / 19,4	250	390
Zylinder Schlauch/Kat.1	30	60	200	19,4 / 19,4	250	440

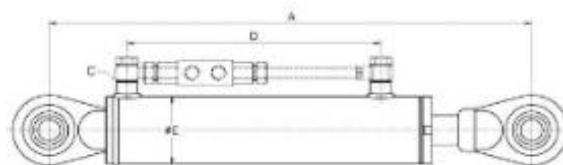

Hydraulischer Oberlenker-Zylinder mit Bohrung doppelwirkend

Bestell-Nr.	Ø Stange mm	Ø A mm	Hub mm	Ø Bolzen mm	Druck max. bar	Einbaumaß mm
Zylinder DW / Bohrung	35	73	180	20 / 20	250	505
Zylinder DW / Bohrung	35	73	230	20 / 20	250	555
Zylinder DW / Bohrung	35	80	185	25 / 25	250	540
Zylinder DW / Bohrung	40	103	185	25 / 25	250	565

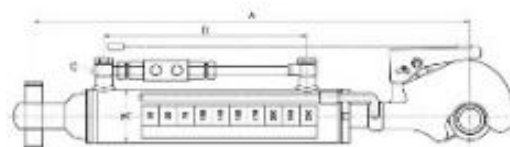



Hydraulischer Gülletankzylinder doppelwirkend 6"

Bestell-Nr.	Ø Stange mm	Ø A mm	Hub mm	Ø I mm	Druck max. bar	Einbaumaß mm
Gülletankzylinder 6"	25	50	150	40	250	360

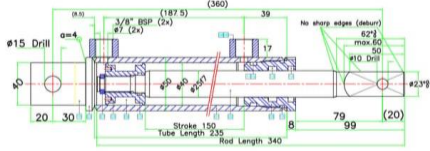
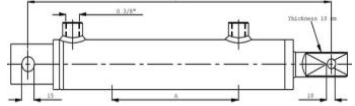
Kompaktzylinder für Gülletank einfachwirkend 6"

Bestell-Nr.	Ø Stange mm	Ø A mm	Hub mm	ges. Länge mm	Druck max. bar	Befestig.
Kompaktzylinder 6"	16	55	100	217	200	M30 x 2
Kompaktzylinder 6"	16	55	150	246	200	M30 x 2
Kompaktzylinder 6"	16	55	200	284,5	200	M30 x 2

Hydraulikzylinder (Gasdruck) für Gülletank einfachwirkend mit Außengewinde

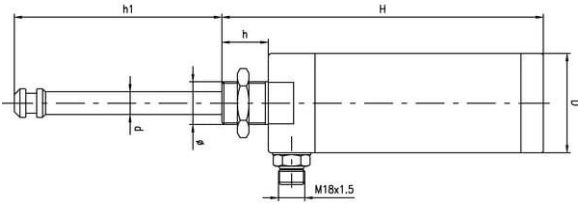
Bestell-Nr.	Ø Stange mm	Ø A mm	Hub mm	Länge o. Stange	Ölanschluss	Gewinde
Zylinder 4"	16	46	133	457	402	AG
Zylinder 5"	16	46	157	457	402	AG
Zylinder 6"	16	46	189	492	436	M30 x 2
Zylinder 8"	16	46	242	865	813	AG
Zylinder 8"	16	46	213	567	503	AG

